

V1=V2

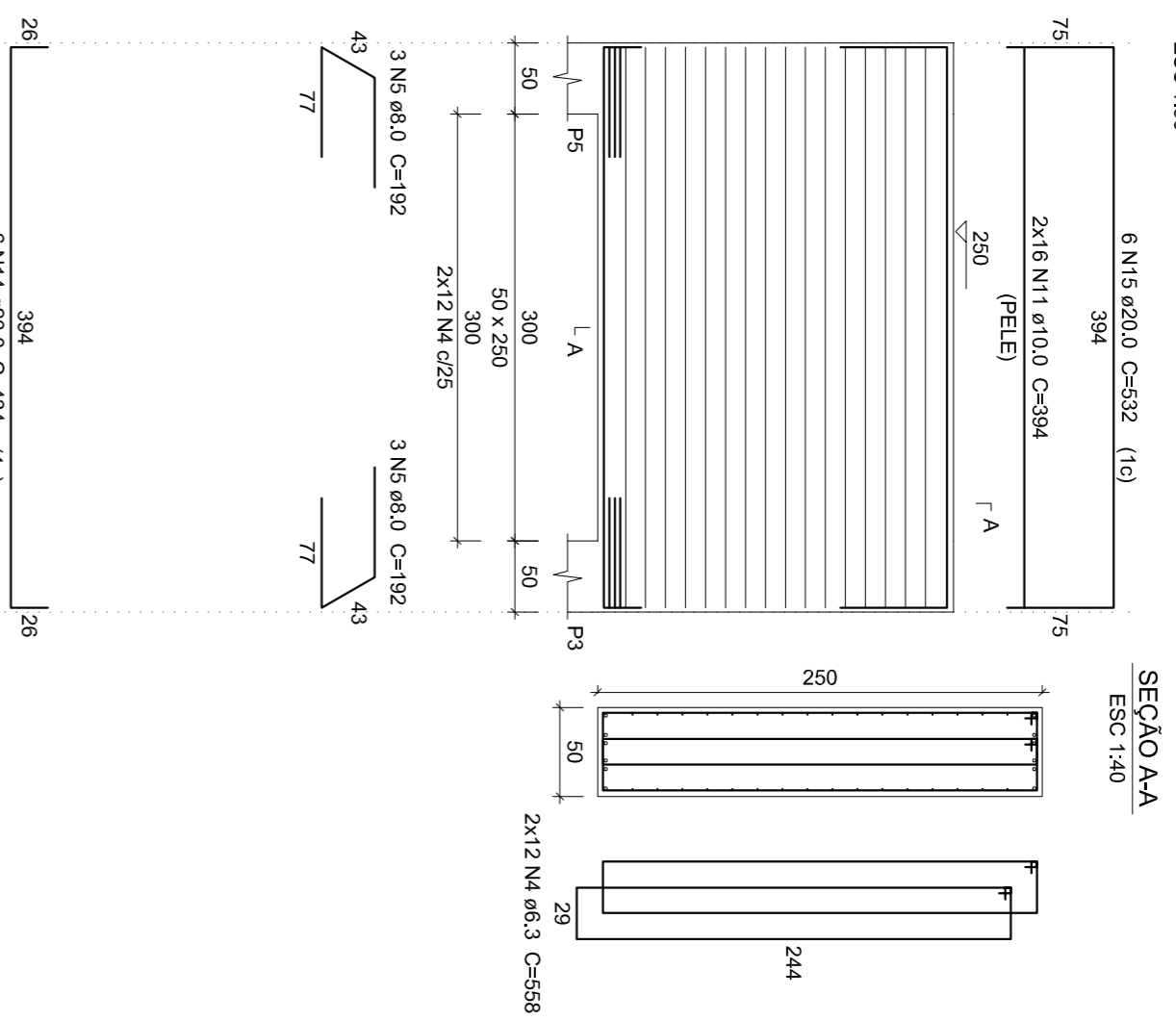

V3=V4

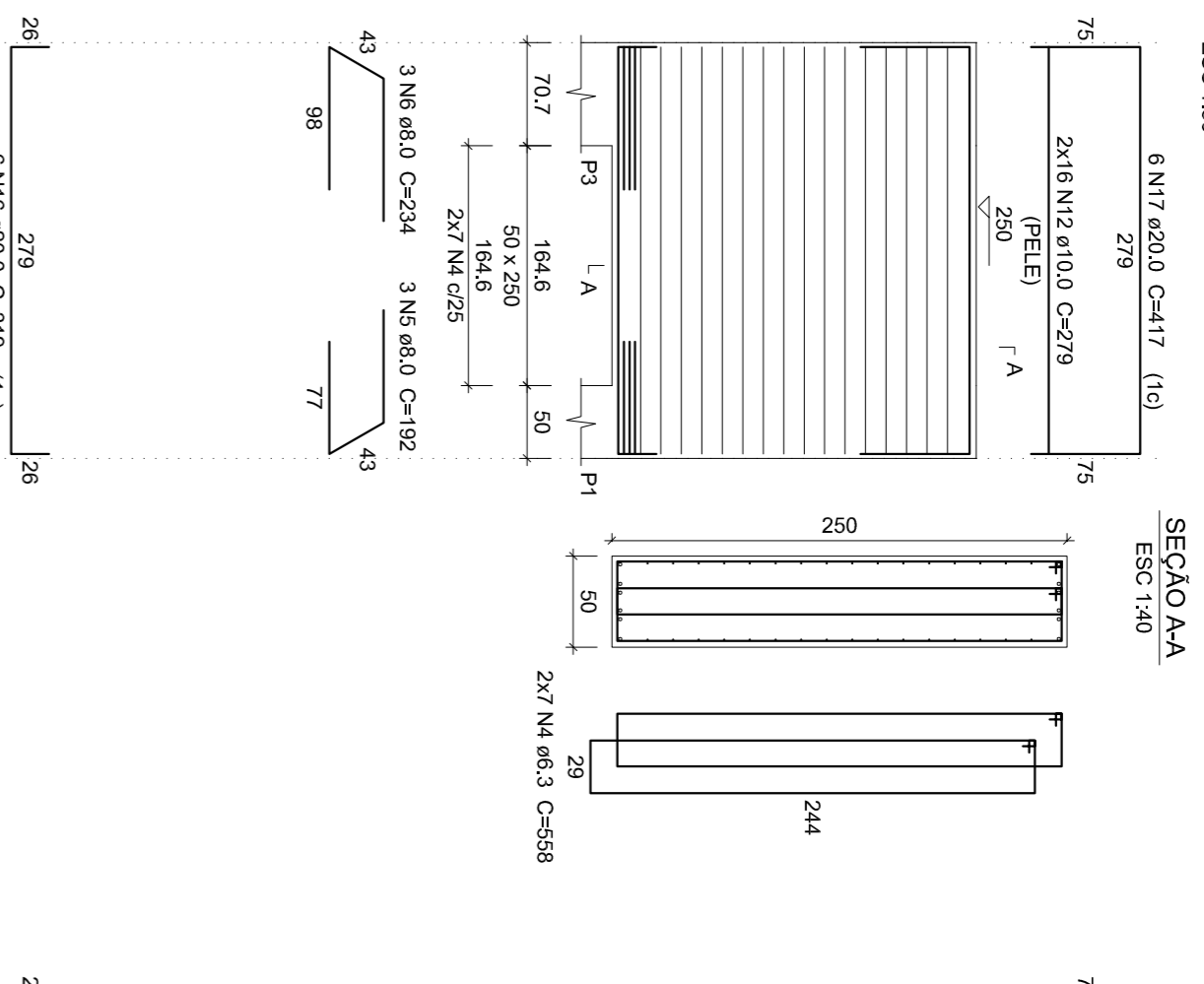

V5=V6

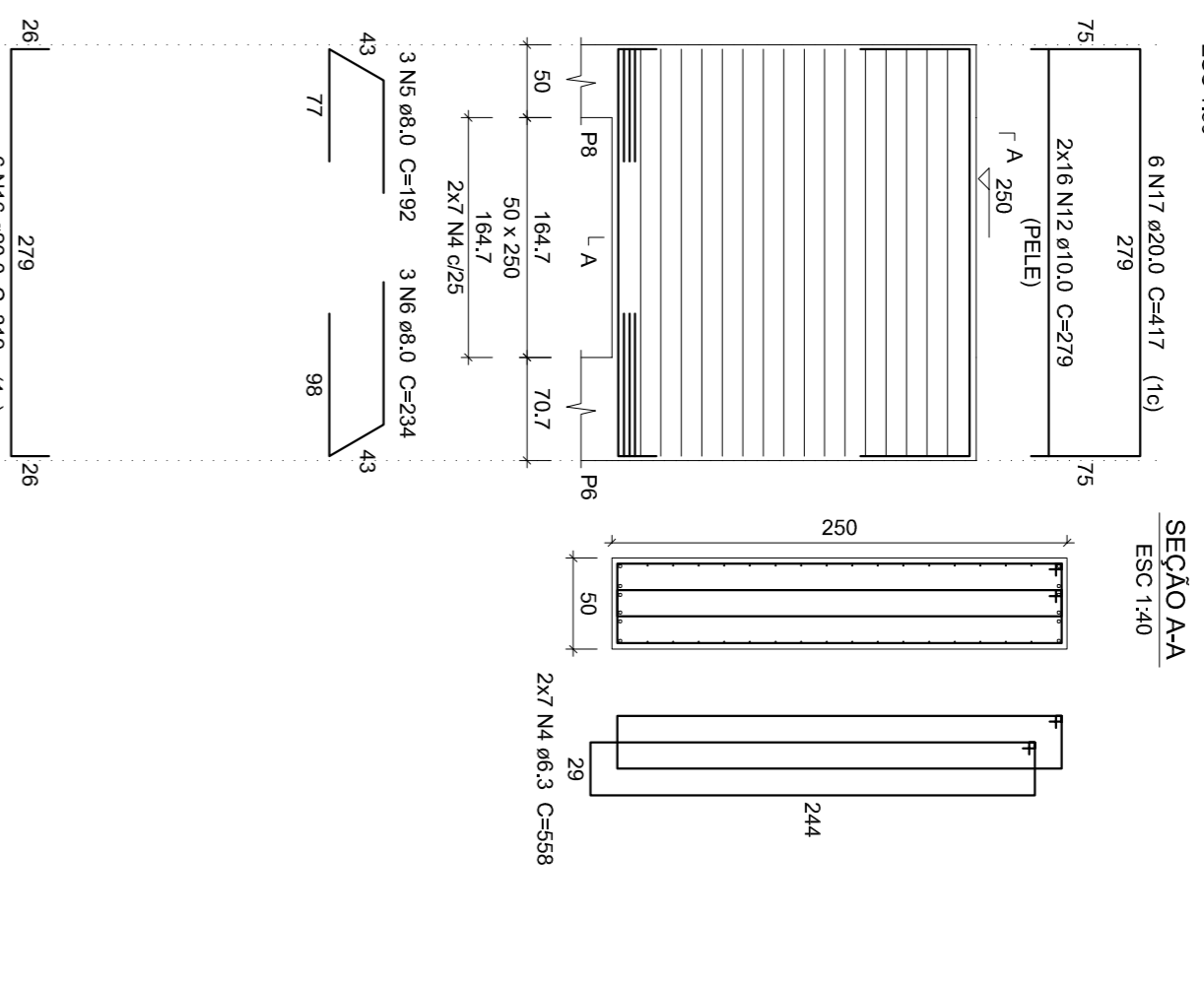

P1=P2=P3=P4=P5=P6=P7=P8

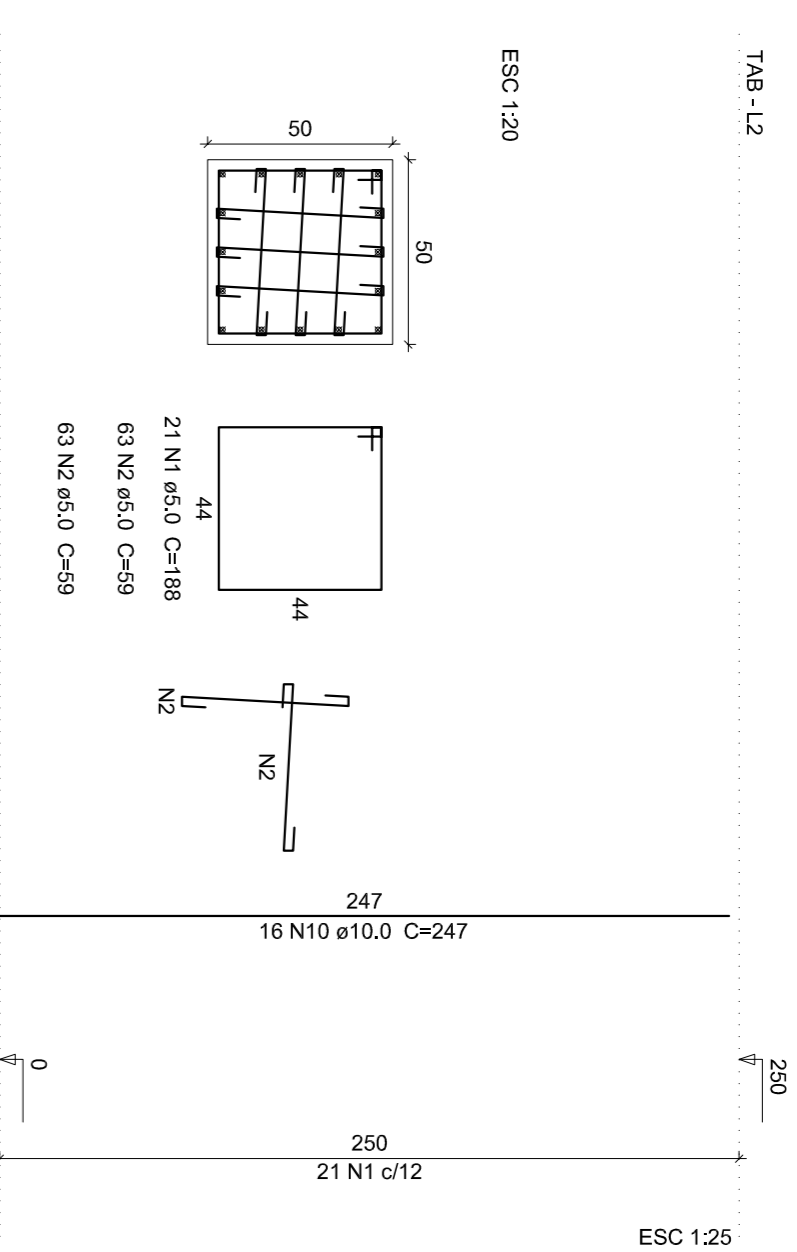

P1=P2=P3=P4=P5=P6=P7=P8

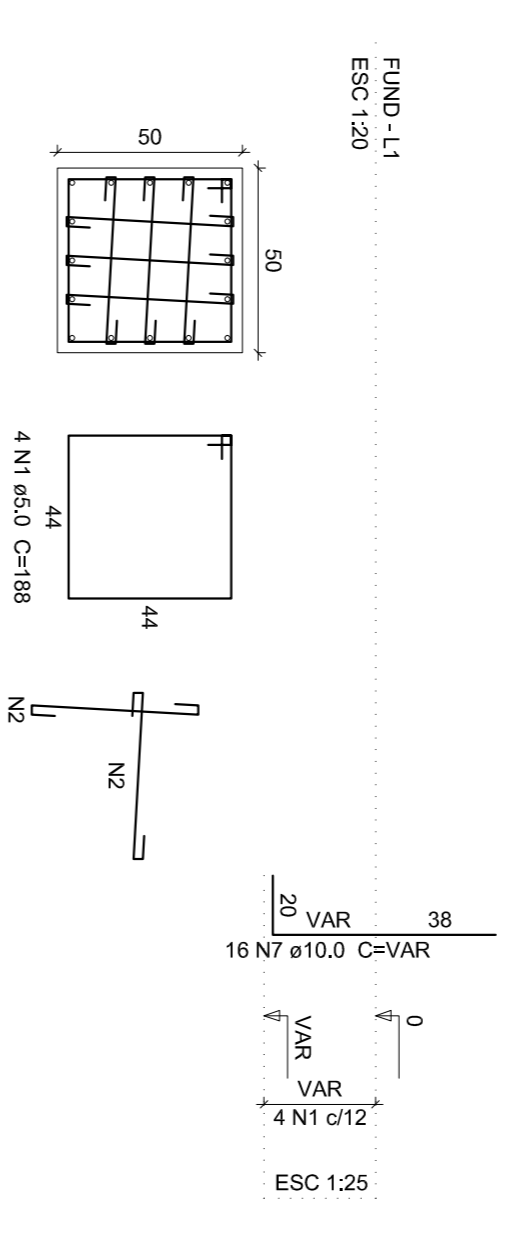

FUND - L1  
ESC:120

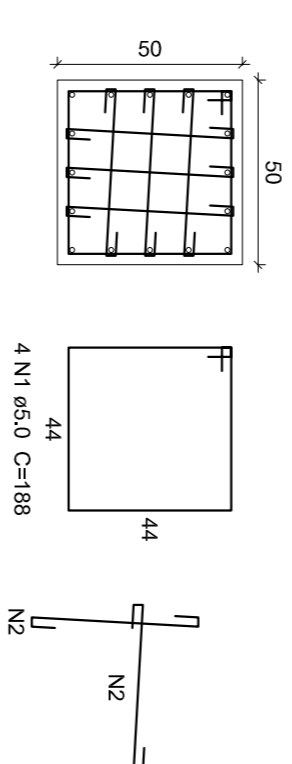

4 N1 ø5.0 C=188  
12 N2 ø5.0 C=59

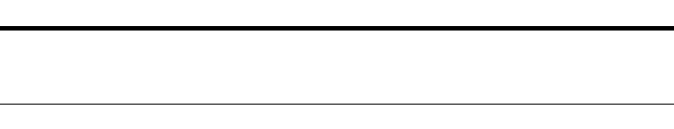
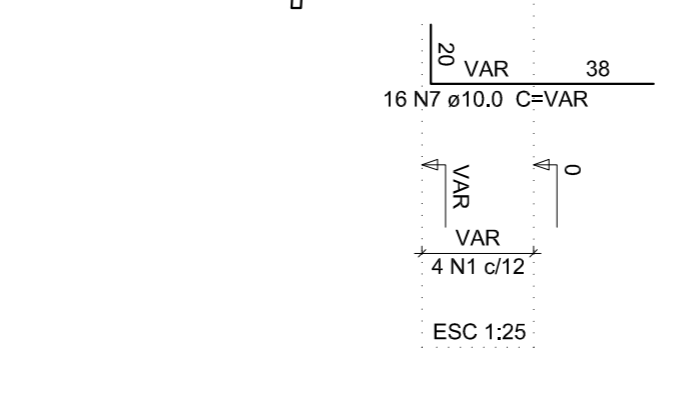
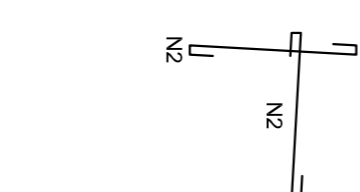

4 N1 ø5.0 C=188  
12 N2 ø5.0 C=59

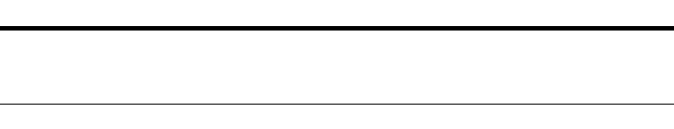
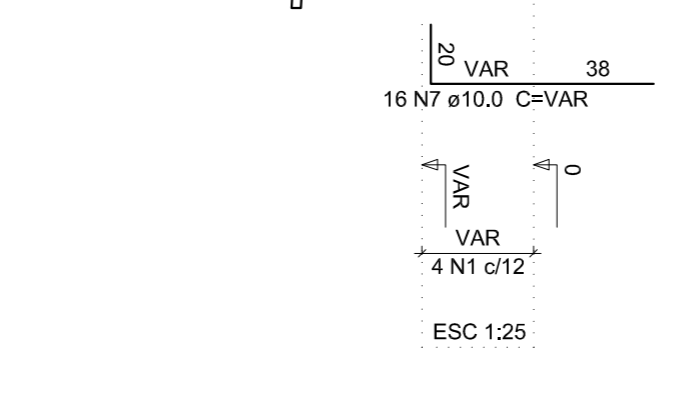
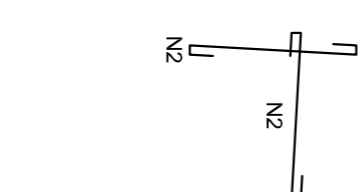

4 N1 ø5.0 C=188  
12 N2 ø5.0 C=59

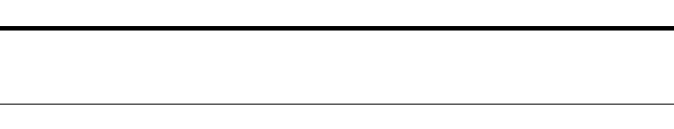
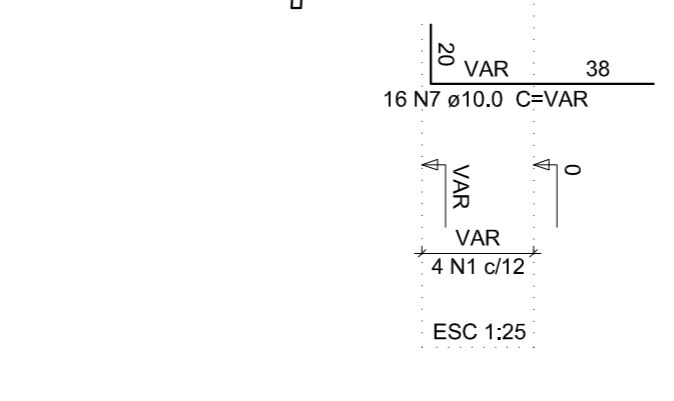
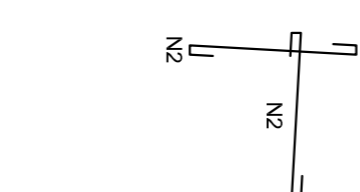

4 N1 ø5.0 C=188  
12 N2 ø5.0 C=59

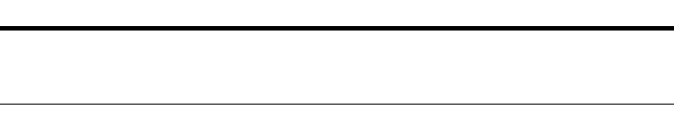
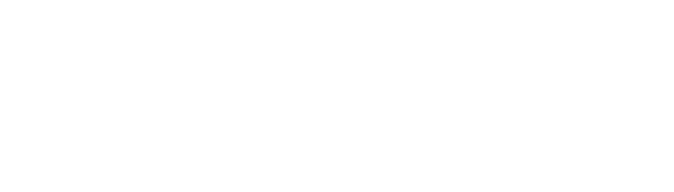
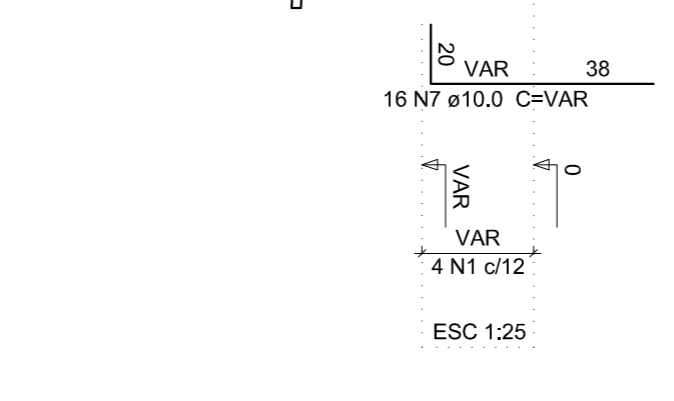
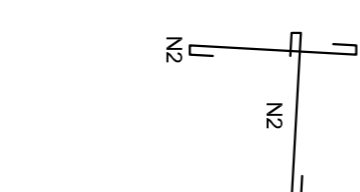

4 N1 ø5.0 C=188  
12 N2 ø5.0 C=59

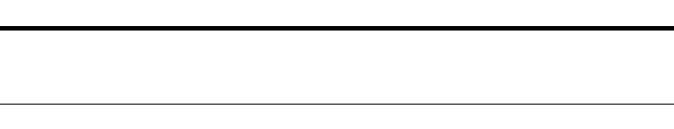
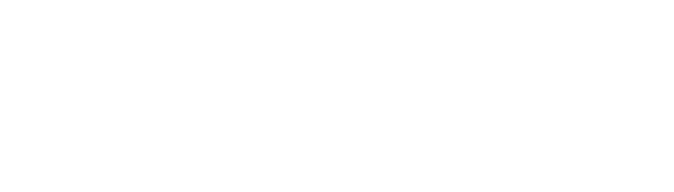
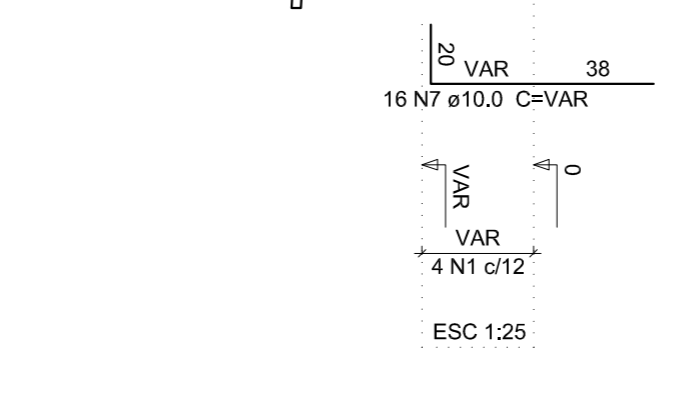
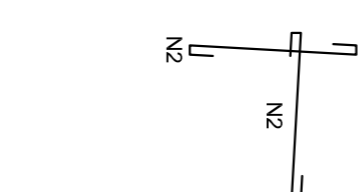

4 N1 ø5.0 C=188  
12 N2 ø5.0 C=59

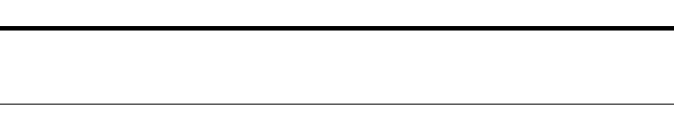
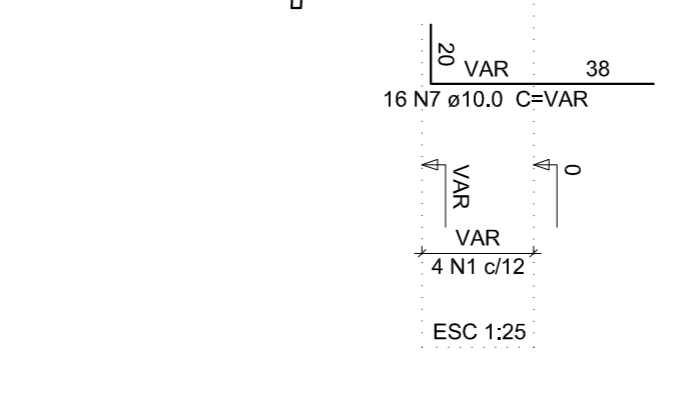
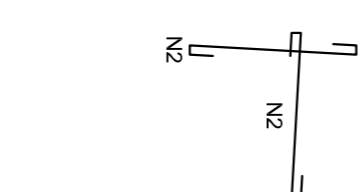

4 N1 ø5.0 C=188  
12 N2 ø5.0 C=59

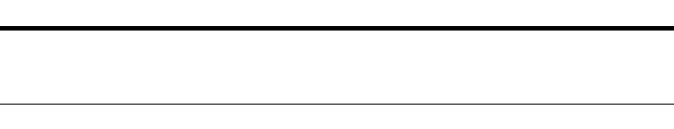
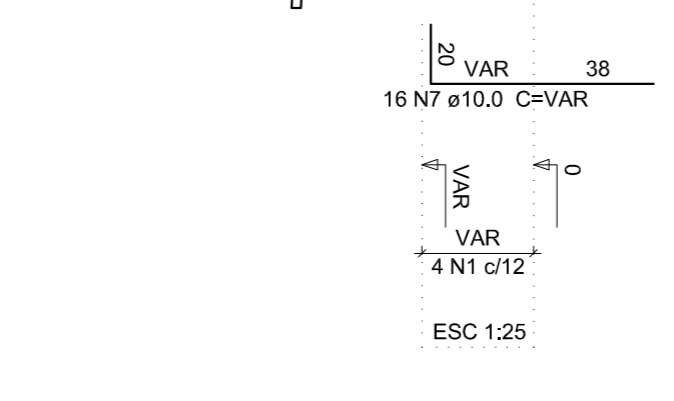
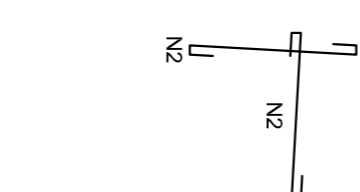

4 N1 ø5.0 C=188  
12 N2 ø5.0 C=59

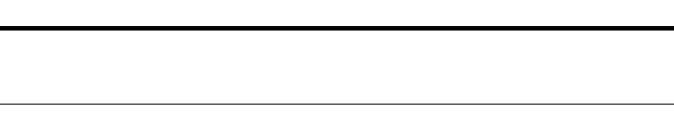
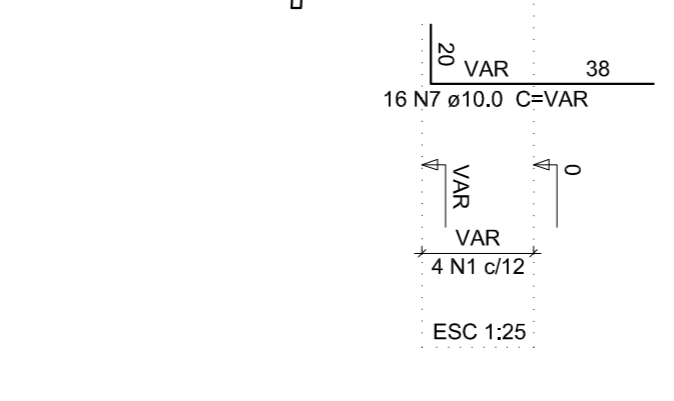
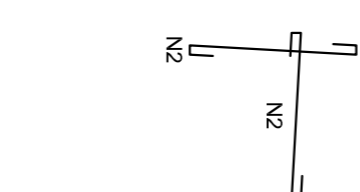

4 N1 ø5.0 C=188  
12 N2 ø5.0 C=59

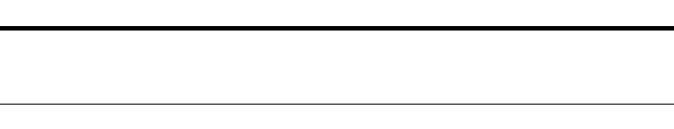
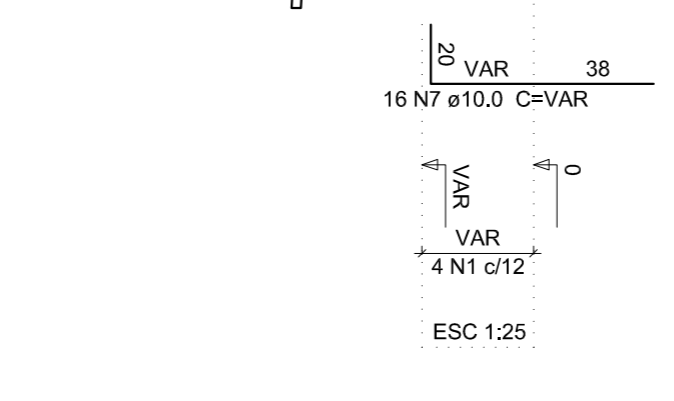
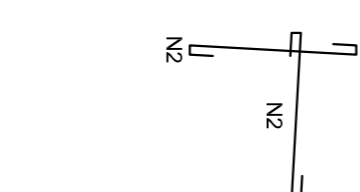

4 N1 ø5.0 C=188  
12 N2 ø5.0 C=59

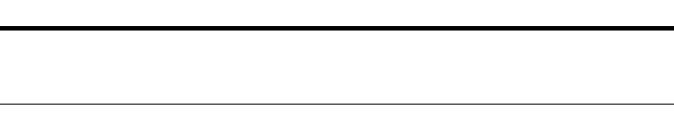
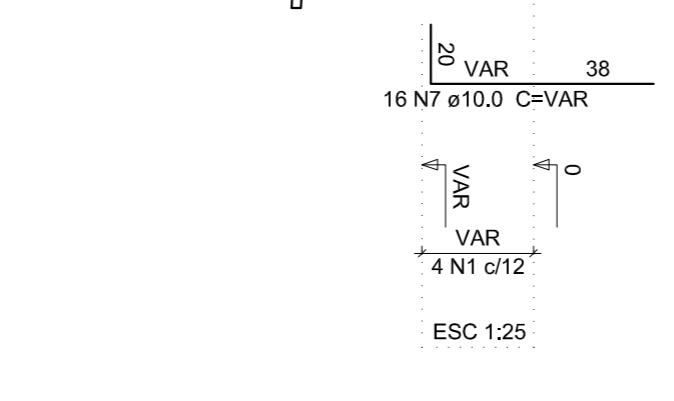
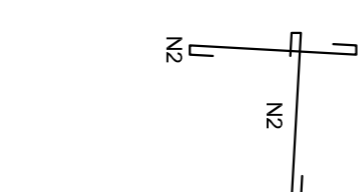

4 N1 ø5.0 C=188  
12 N2 ø5.0 C=59

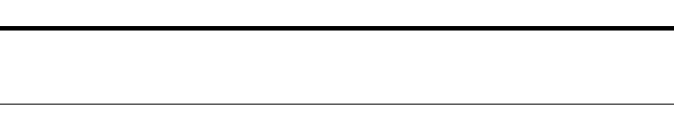
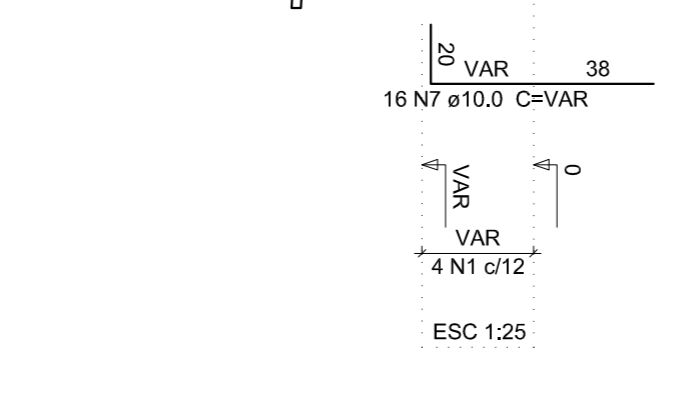
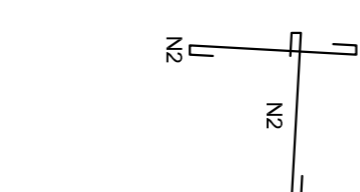

4 N1 ø5.0 C=188  
12 N2 ø5.0 C=59

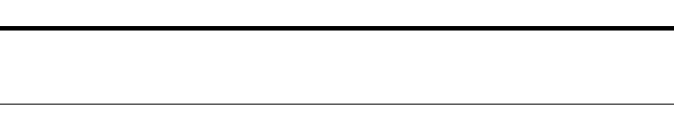
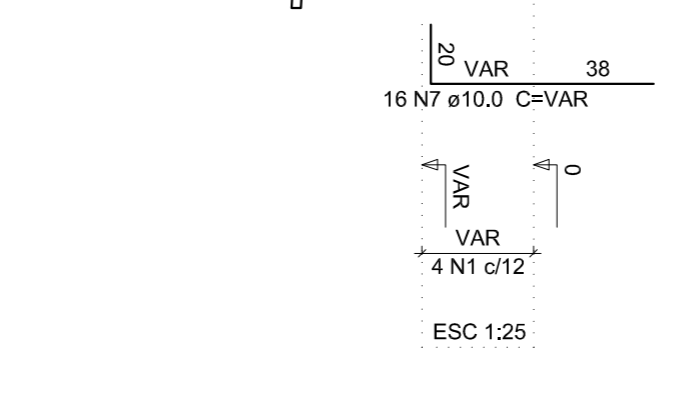
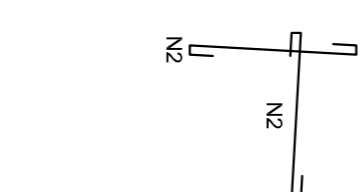

4 N1 ø5.0 C=188  
12 N2 ø5.0 C=59

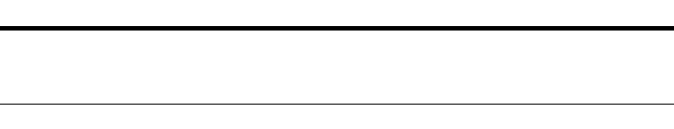
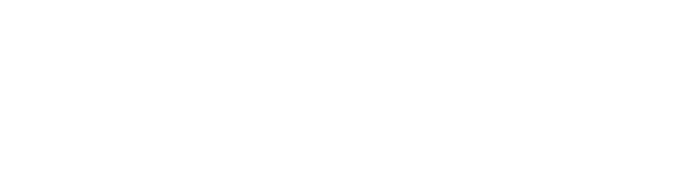
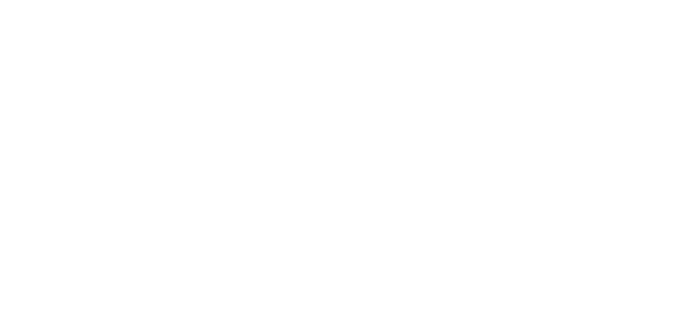
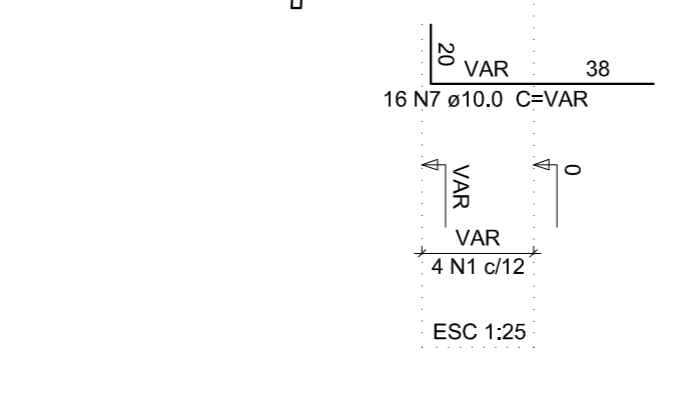
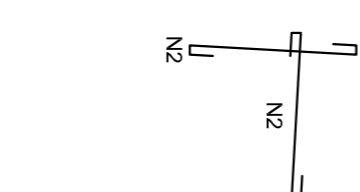

4 N1 ø5.0 C=188  
12 N2 ø5.0 C=59

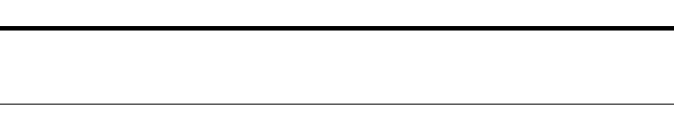
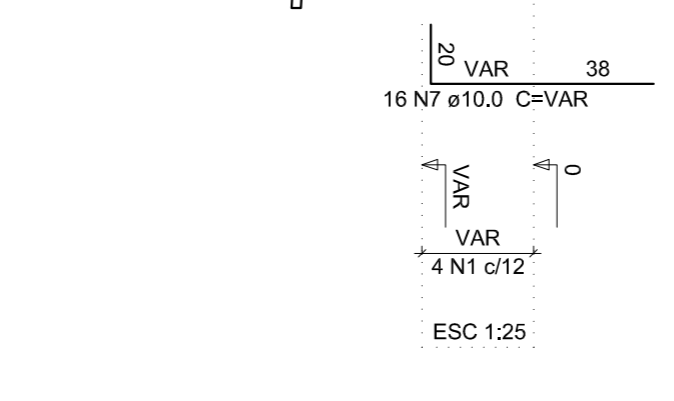
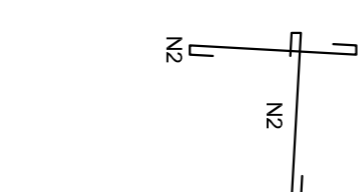

4 N1 ø5.0 C=188  
12 N2 ø5.0 C=59

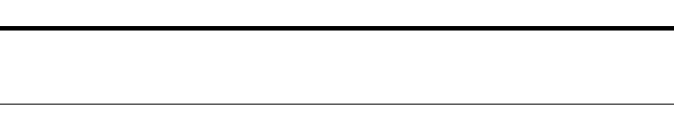
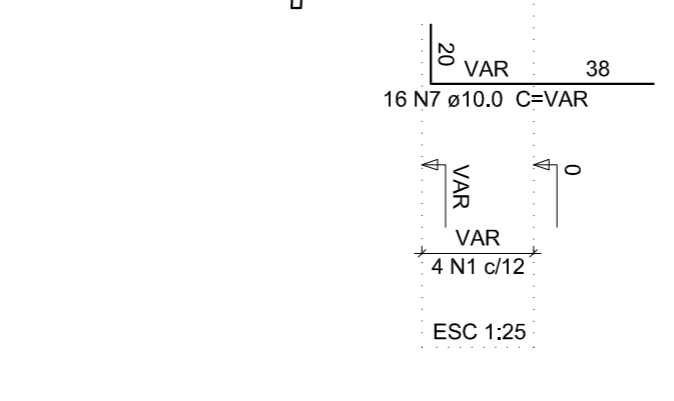
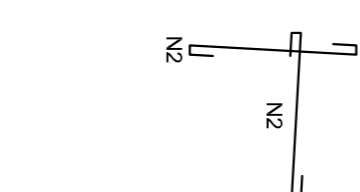

4 N1 ø5.0 C=188  
12 N2 ø5.0 C=59

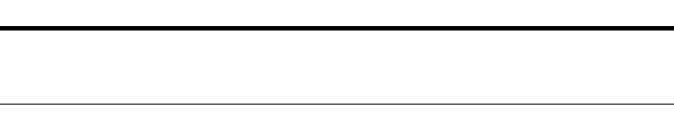
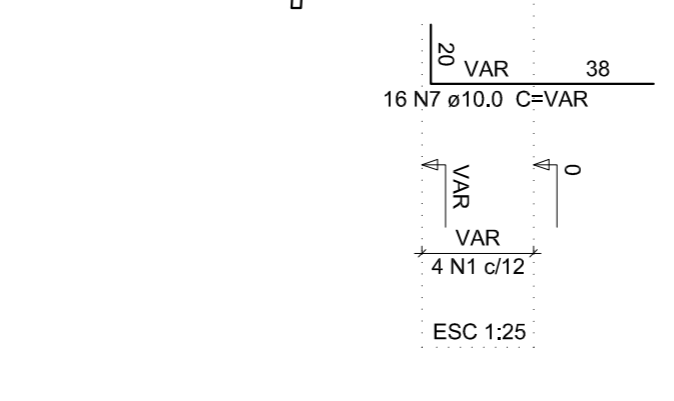
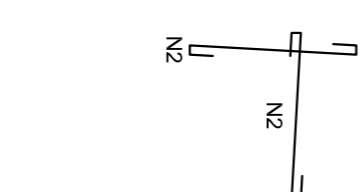

4 N1 ø5.0 C=188  
12 N2 ø5.0 C=59

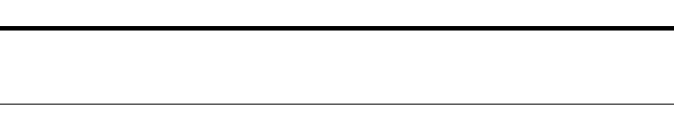
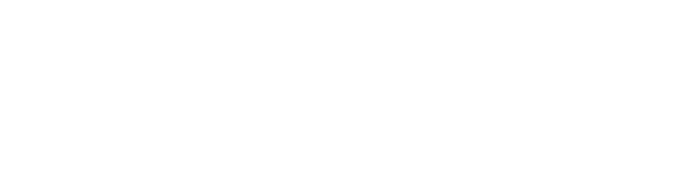
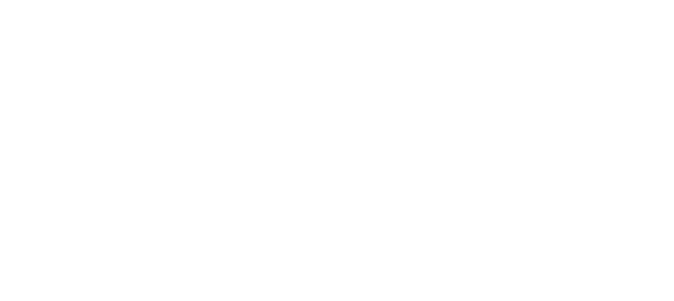
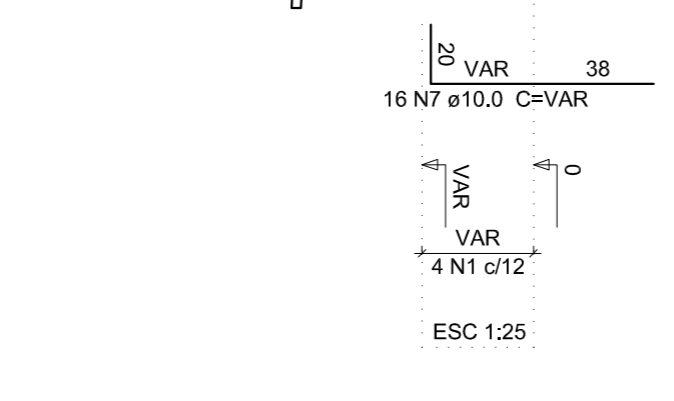
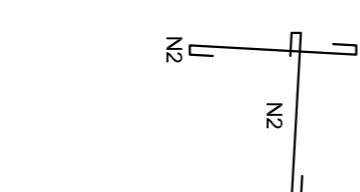

4 N1 ø5.0 C=188  
12 N2 ø5.0 C=59

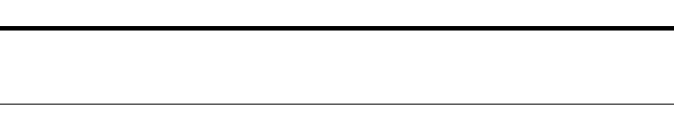
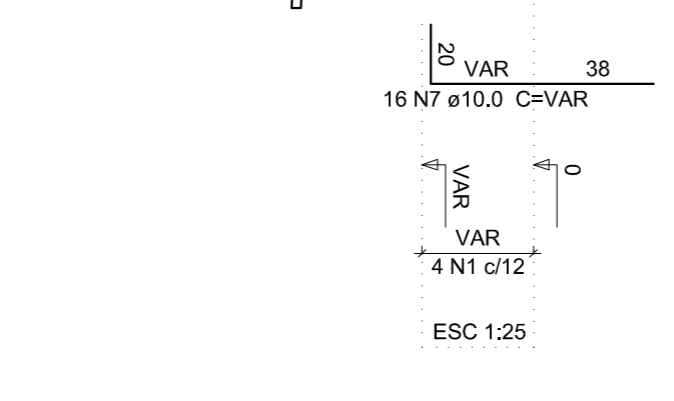
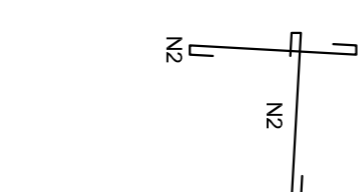

4 N1 ø5.0 C=188  
12 N2 ø5.0 C=59

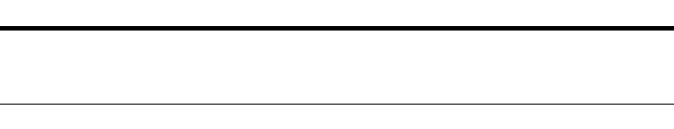
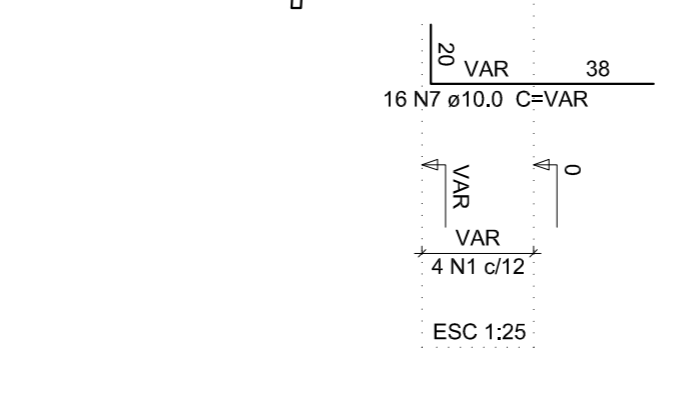
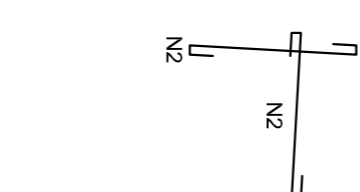

4 N1 ø5.0 C=188  
12 N2 ø5.0 C=59

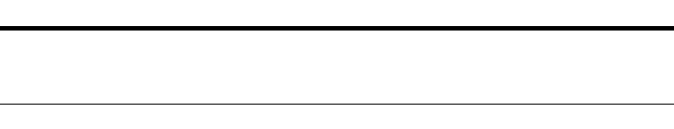
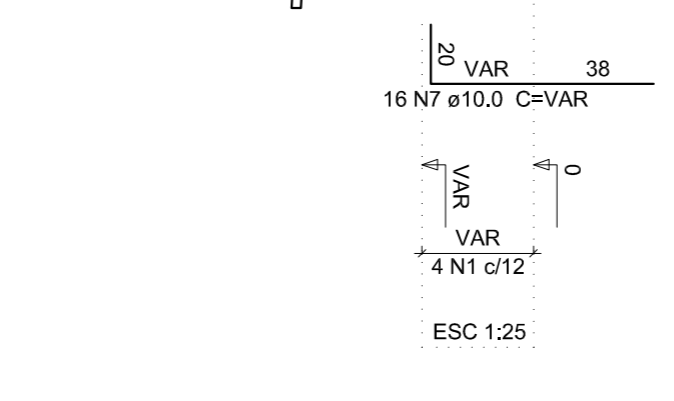
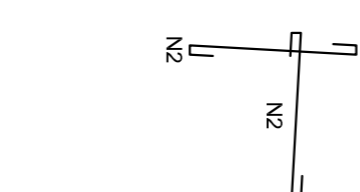

4 N1 ø5.0 C=188  
12 N2 ø5.0 C=59

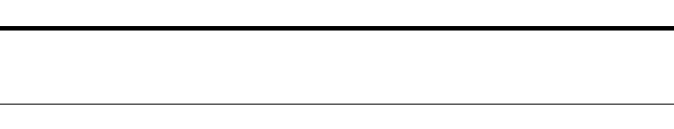
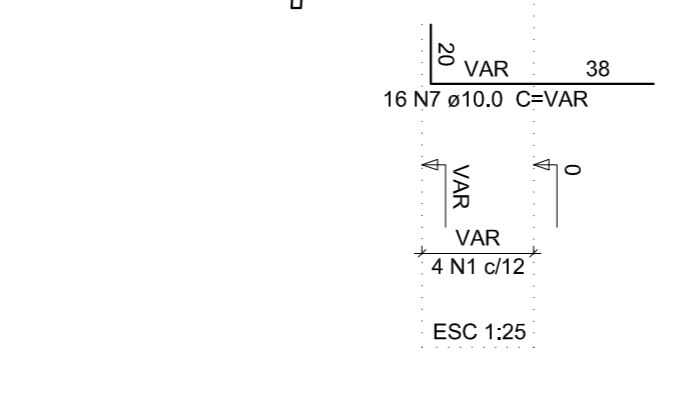
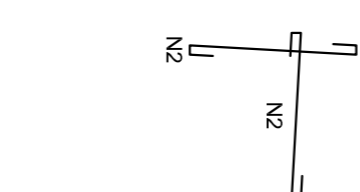

4 N1 ø5.0 C=188  
12 N2 ø5.0 C=59

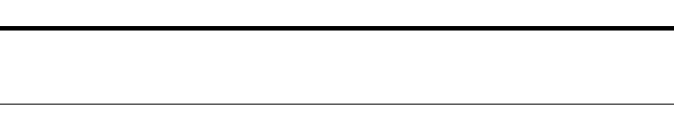
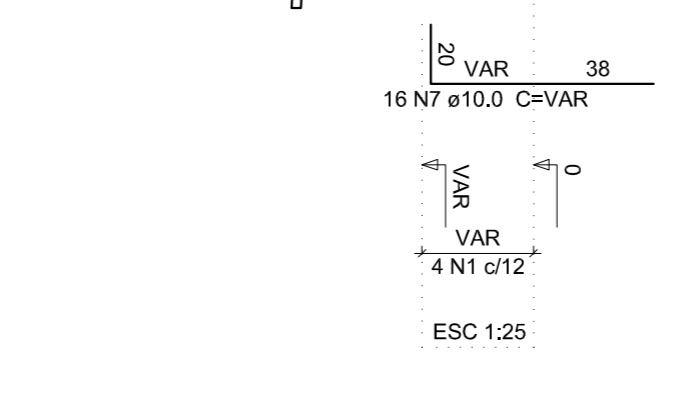
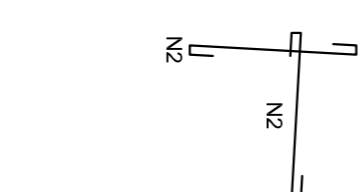

4 N1 ø5.0 C=188  
12 N2 ø5.0 C=59

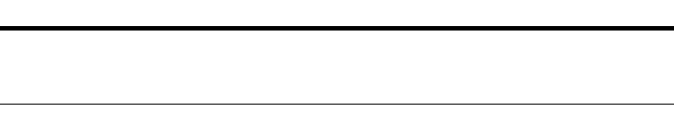
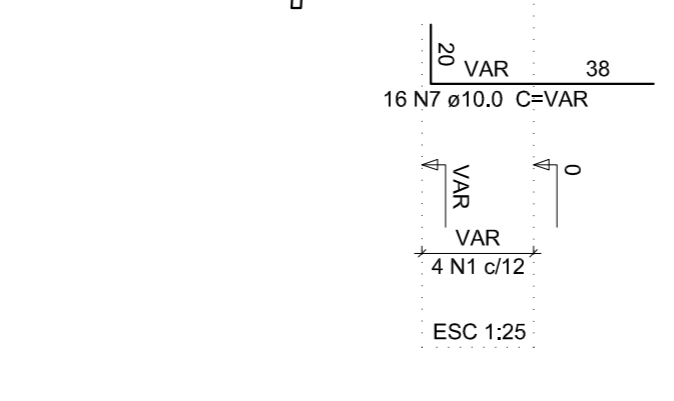
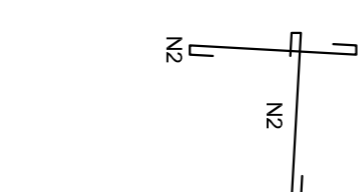

4 N1 ø5.0 C=188  
12 N2 ø5.0 C=59

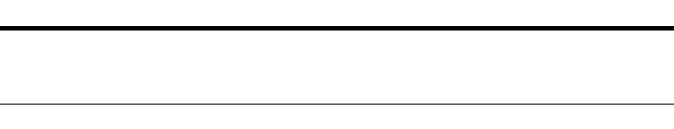
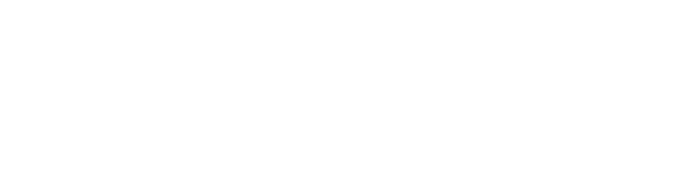
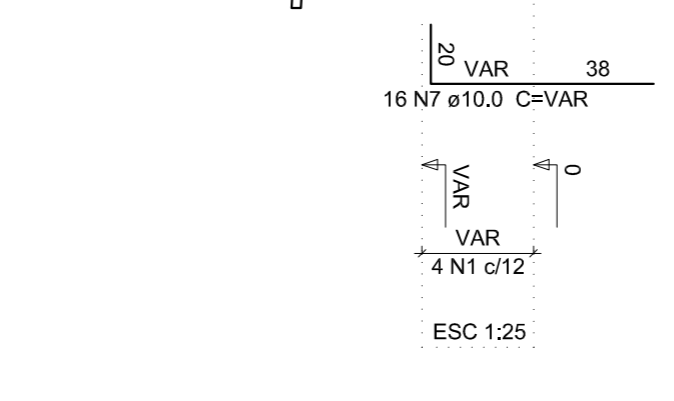
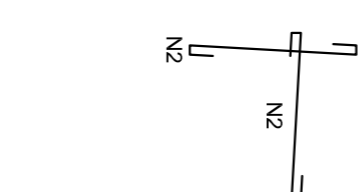

4 N1 ø5.0 C=188  
12 N2 ø5.0 C=59

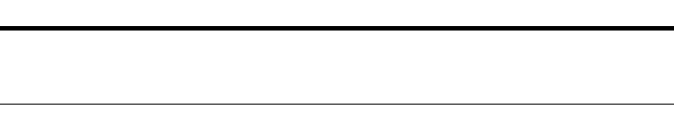
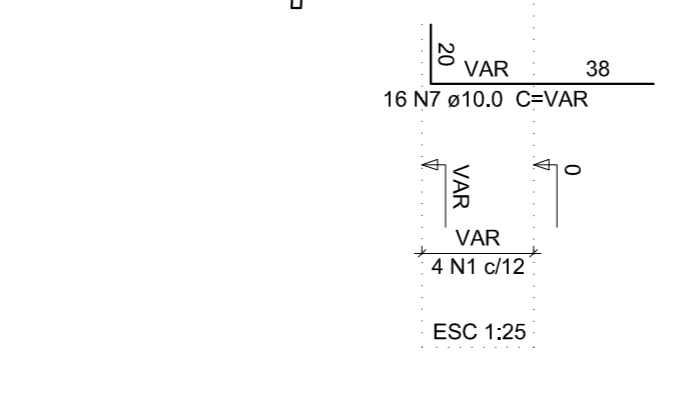
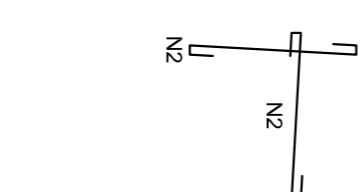

4 N1 ø5.0 C=188  
12 N2 ø5.0 C=59

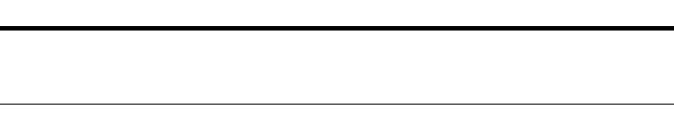
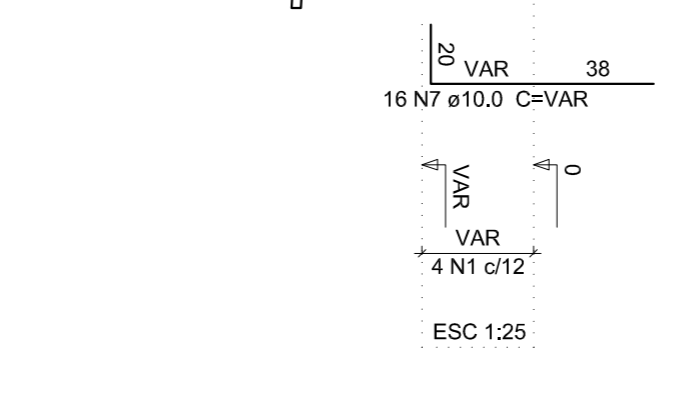
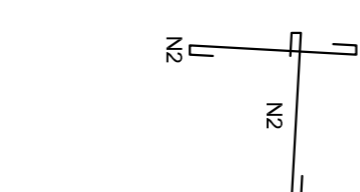

4 N1 ø5.0 C=188  
12 N2 ø5.0 C=59

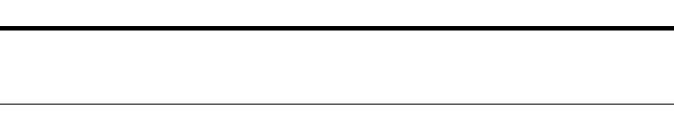
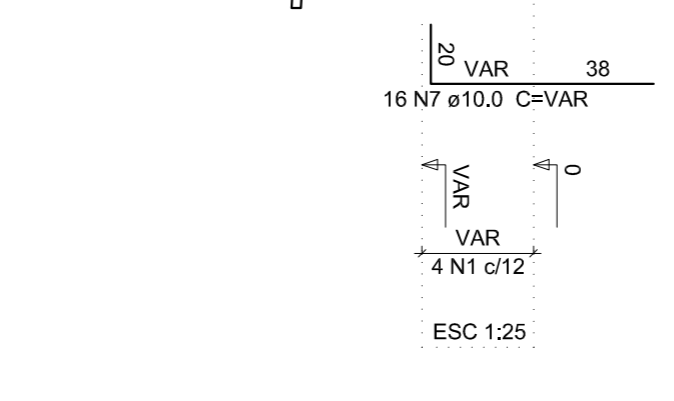
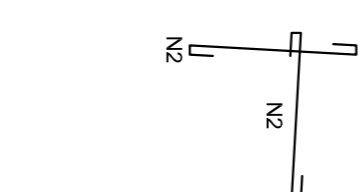

4 N1 ø5.0 C=188  
12 N2 ø5.0 C=59

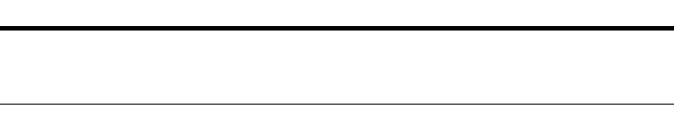
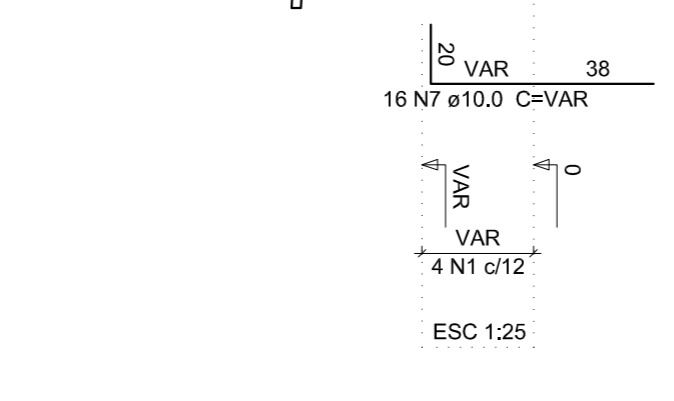
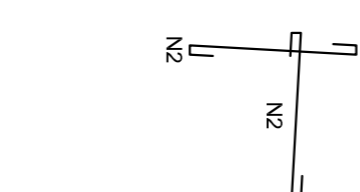

4 N1 ø5.0 C=188  
12 N2 ø5.0 C=59

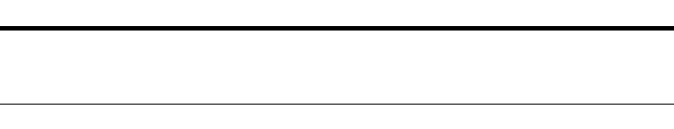
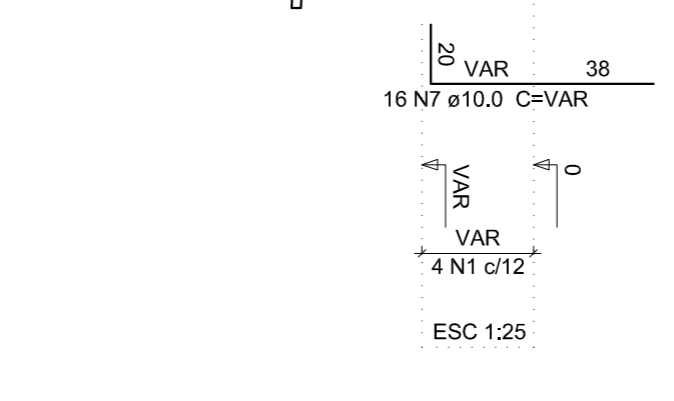
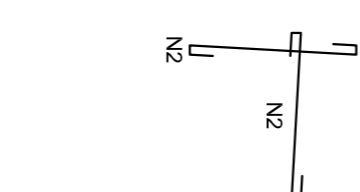

4 N1 ø5.0 C=188  
12 N2 ø5.0 C=59

